

ask for the
MOON



WE'VE GOT IT COVERED

**FLOOR COVERING
ACCESSORIES**

THE *Loxscreen* COMPANY, INC.

CARPET EDGE – PIN TYPE

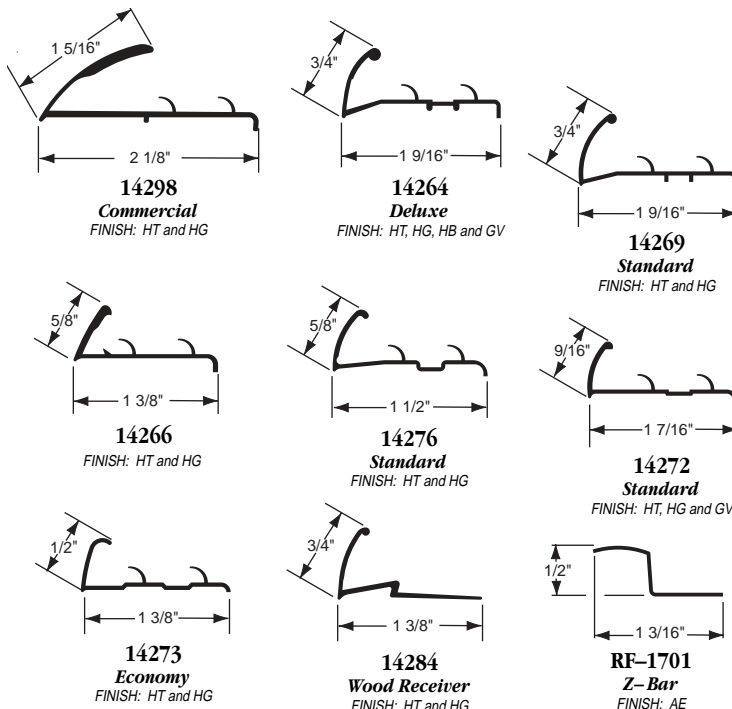

PACKAGING INFORMATION:

40 PIECES PER TUBE 14298 – 12 PCS. FLEX – 12 PCS. RF1701 – 25 – 4' PCS. PER CARTON NO FASTENERS

Loxscreen believes customers should get what they want – when they want it. So, if you want the moon, we've got it covered. Quite literally, in fact.

Our new line of floor covering accessories is processed meticulously providing a rich textured appearance. We offer eight finishes; hammered or not hammered, satin anodized or brite. Whether it's for commercial or residential use, the finish makes our extrusions complimentary to any type of flooring. Loxscreen extrusions also provide the ultimate in gripping power, preventing wear and tear on all coverings - from vinyl to carpet.

CARPET EDGE – PINLESS

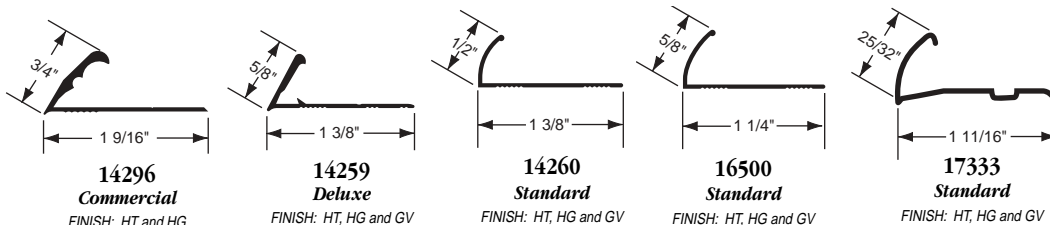

PACKAGING INFORMATION:

40 PIECES PER TUBE FLEX – 12 PCS. NO FASTENERS

CARPET BAR

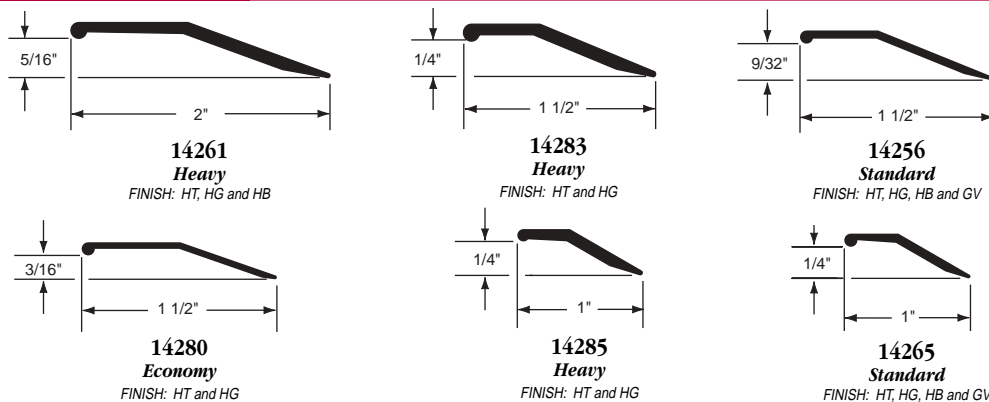

PACKAGING INFORMATION:

40 PIECES PER TUBE FASTENERS

SEAM BINDER

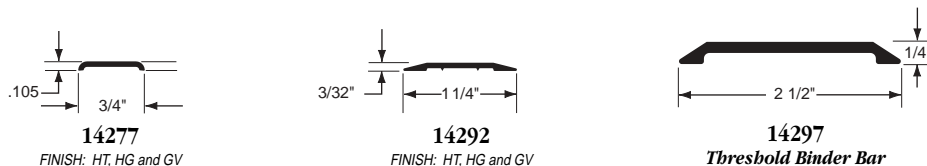

PACKAGING INFORMATION:

40 PIECES PER TUBE FASTENERS 14297 - 12 PCS (NO FASTENERS)

CERAMIC TILE TRIM

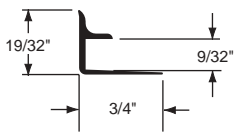

99929
Tile Cove
FINISH: SS and SG

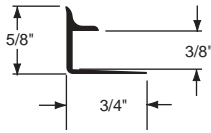

17134
Tile Cove
FINISH: SS and SG

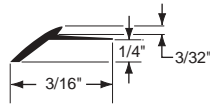

14291
Underlayment
for 3/32" Material
FINISH: HT and HG

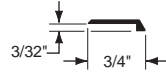

14802
Linoleum Edge
FINISH: HT, HG and GV

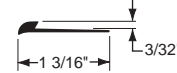

14860
V-Edge
FINISH: SS and SG

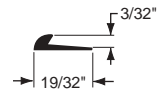

17135
V-Edge
FINISH: SS and SG

PACKAGING INFORMATION: 12 PIECES PER TUBE
99929 & 99930 - 144" ALL OTHERS 98"

PACKAGING INFORMATION: 40 PIECES PER TUBE FASTENERS 14802 ONLY

STAIR NOSING

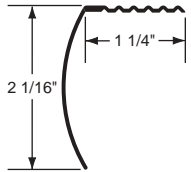

14295
FINISH: HT and HG

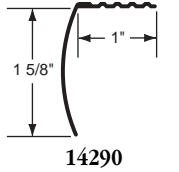

14290
FINISH: HT, HG, HB and GV

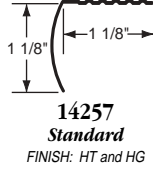

14257
Standard
FINISH: HT and HG

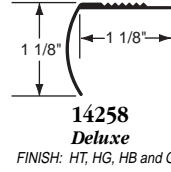

14258
Deluxe
FINISH: HT, HG, HB and GV

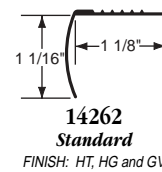

14262
Standard
FINISH: HT, HG and GV

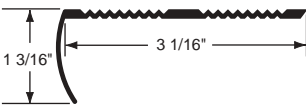

14293
Tread for 3/32" Material
FINISH: MB and SG

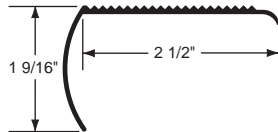

14294
Stair Tread
FINISH: MB and SG

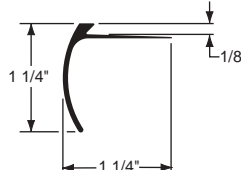

17352
For 1/8" Material
FINISH: HT and HG

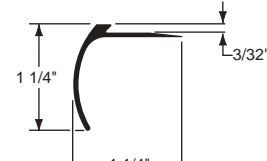

17353
For 3/32" Material
FINISH: HT and HG

PACKAGING INFORMATION: 40 PIECES PER TUBE 14294 & 14293 - 12 PCS. FASTENERS

DIVIDERS

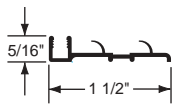

14270
Track w/Pins
(Accepts Vinyl Insert)
FINISH: AE

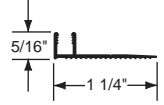

14271
Pinless Track
(Accepts Vinyl Insert)
FINISH: AE

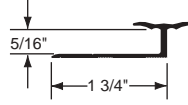

14299
Pinless Carpet Divider
FINISH: HT and HG

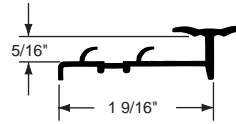

14300
Carpet Divider w/Pins
FINISH: HT and HG

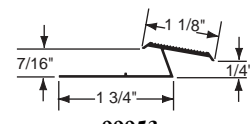

99953
Multi-Purpose Z Shape
FINISH: SS and SG

PACKAGING INFORMATION: 14270 & 14271 - 20 PACK 14299 & 14300 - 24 PACK FLEX - 12 PACK NO FASTENERS

CAPS, COVES & EDGINGS

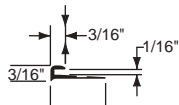

14288
1/16" Small Face Cap
FINISH: SS and SG

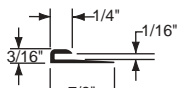

14287
1/16" Cap
FINISH: SS and SG

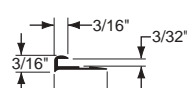

14861
3/32" Small Face Cap
FINISH: SS and SG



16501
3/32" Small Face Cap
FINISH: SS and SG

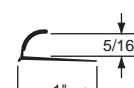

14267
5/16" Carpet Cove Cap
FINISH: HT and HG

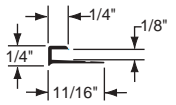

14281
1/8" Square Cove Cap
FINISH: SS and SG

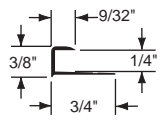

14282
1/4" Square Cove Cap
FINISH: SS and SG

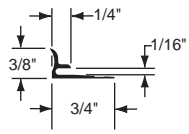

14289
1/16" Insert Cove
FINISH: SS and SG

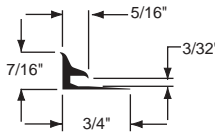

18176
3/32" Insert Cove
FINISH: SS and SG

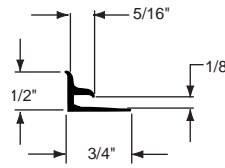

99951
1/8" Insert Cove
FINISH: SS and SG

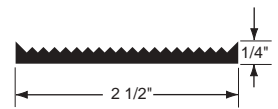

14740
FINISH: SS
3', 4' or 6'

PACKAGING INFORMATION: 40 PIECES PER TUBE NO FASTENERS

PACKAGING INFORMATION: 6 PIECES PER TUBE

Loxcren
Finishes

HT
Hammered
As Extruded

HG
Hammered
Satin Gold
Anodized

HB
Hammered
Brite Gold
Anodized

HS
Hammered
Etched Clear
Anodized

HZ
Hammered
Brite Bronze
Anodized

AE
As Extruded

SS
Super Satin
Anodized

SG
Satin Gold
Anodized

GV
Gold Vein
Powder Coat

MB
Mill Brite

MG
Mill Brite
Gold

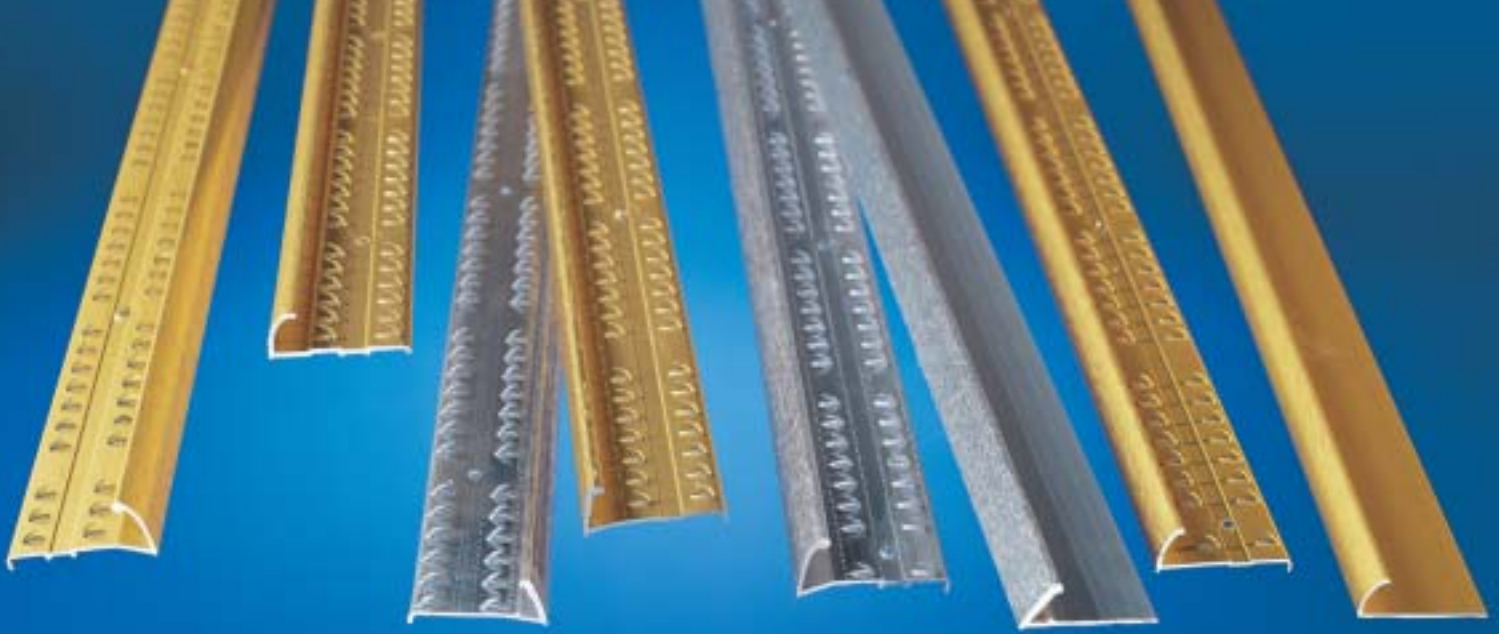

Loxcreen is a leader in the aluminum and vinyl extrusion business and that is why we can offer an extensive selection of quality floor covering trim. We are committed to always having the product you need - when you need it. We do this so turnaround will always be quick and you always make your deadlines. You will come to depend on Loxcreen for quality products and prompt delivery.

Although Loxcreen continues to seek out new challenges, our primary focus remains the same - to always provide quality extrusions to our loyal family of customers.

With our new product line, we think you'll see we continue to accomplish our goal. So, go ahead - the moon is yours for the asking.

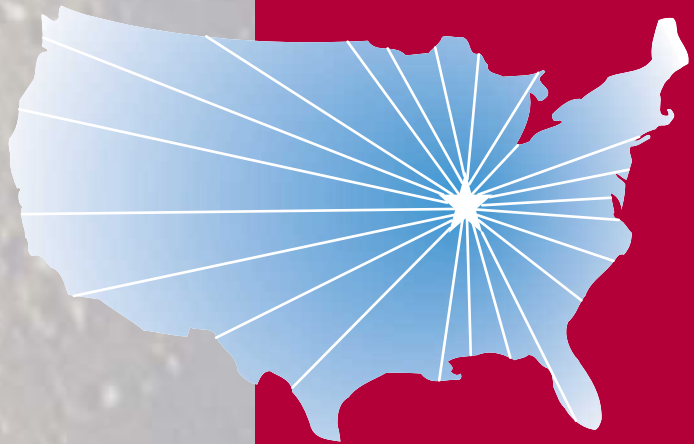

Loxcreen provides unparalleled nationwide customer service through our prompt, expedient delivery system. Our main goal is to always provide the quickest and the most efficient delivery service in the extrusion industry.

THE *Loxcreen* COMPANY, INC.

Atlanta, GA
888-357-8746
Fax 770-729-9478

Arlington, TX
800-222-4629
Fax 817-649-1760

Hayti, MO
800-323-8314
Fax 573-359-2814

Lebanon, OH
800-432-4672
Fax 513-932-7035

Roxboro, NC
800-682-9586
Fax 910-597-8821

Sanford, FL
800-330-5699
407-323-5918

www.loxcreen.com